

CONNECTEURS

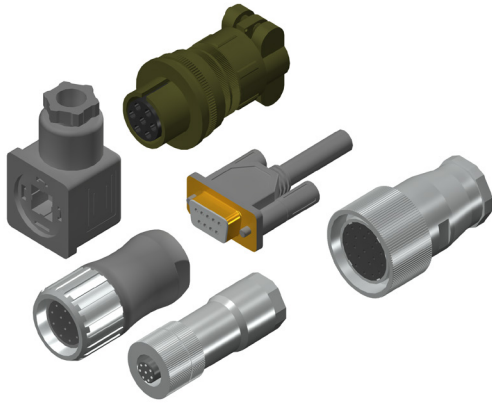

95.0007179
M8 3p

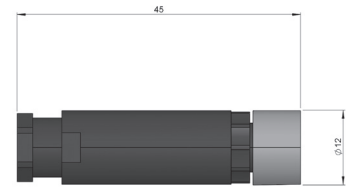
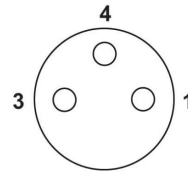

95.0007076
M12 4p horaire

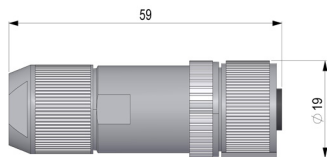
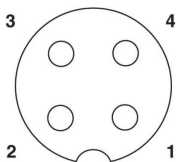

95.0007077
M12 4p anti-horaire

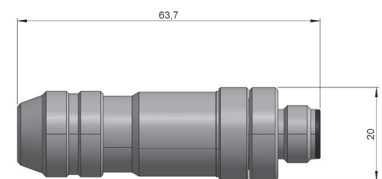
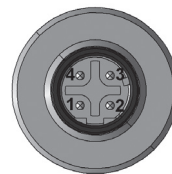

95.0007011
DIN 43650

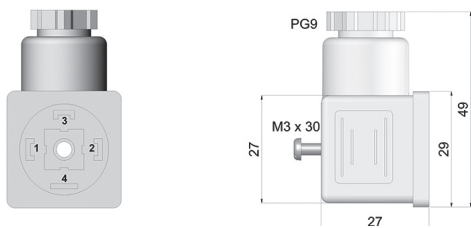

90.9507H
Militar 7p anti-horaire

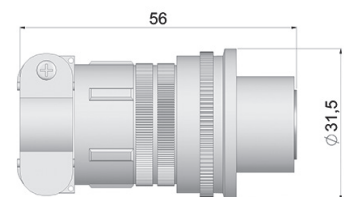
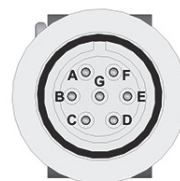

95.0007152
M12 8p horaire

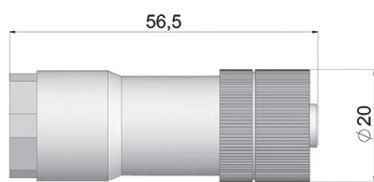
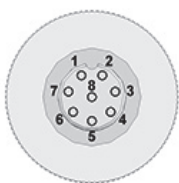

90.9510H
Militar 10p anti-horaire

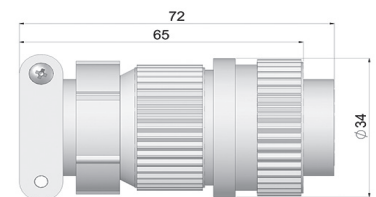

95.0007149
M16 12p anti-horaire

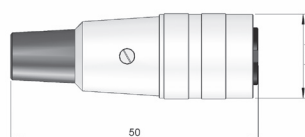
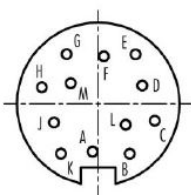

95.0007131
M23 12p anti-horaire

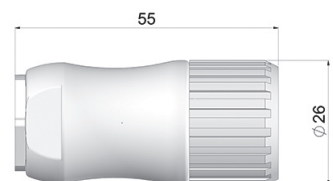

CONNECTEURS

95.0007137

M23 12p horaire

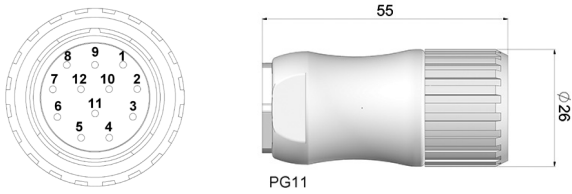

90.9589H

D-Sub 9p

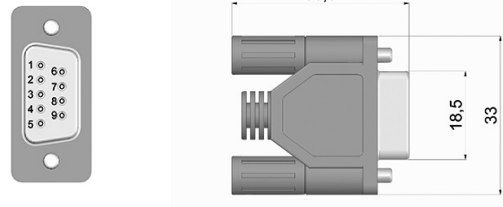

95.0007006

M23 16p anti-horaire

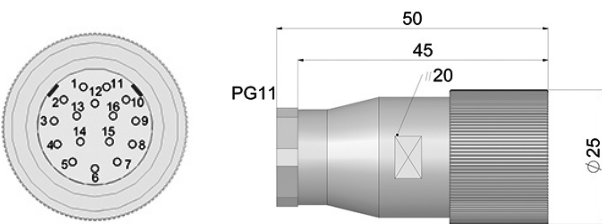

95.0007062

21p anti-horaire

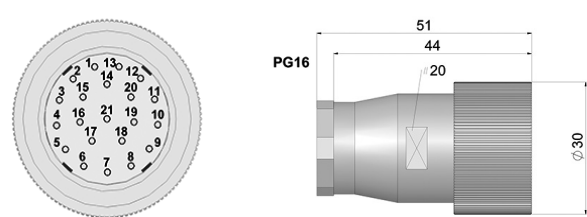

95.0007063

26p anti-horaire

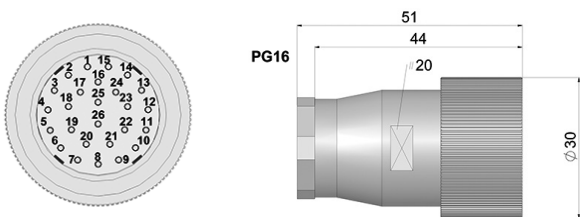

90.9537H

37p

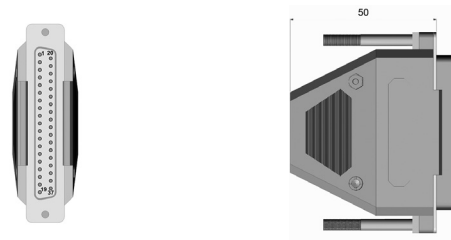

90.9552

M12 5p

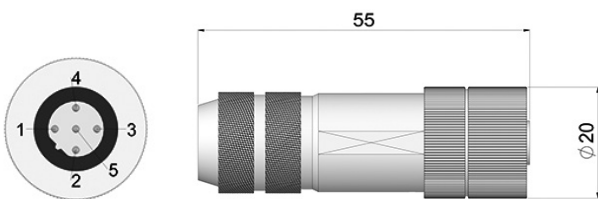

90.9553

M12 5p

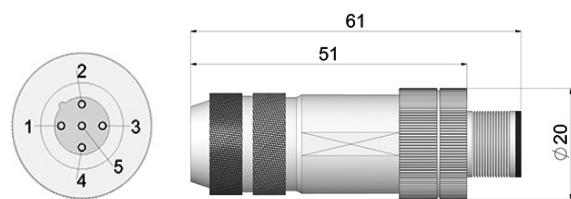

90.9554

M12 4p horaire

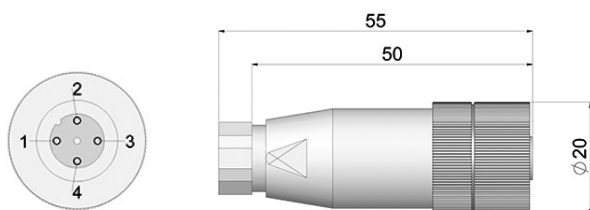

90.9550

M12 5p

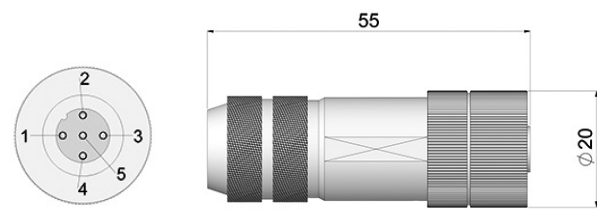

CONNECTEURS

90.9551
M12 5p

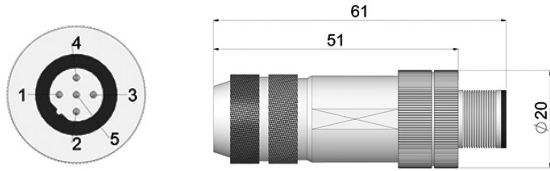

90.9546H
D-Sub 15p

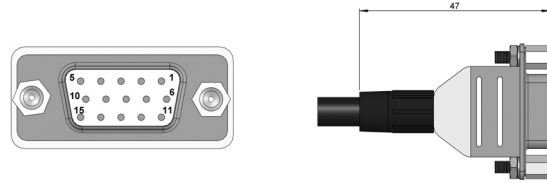

95.0007196
M23 17p anti-horaire

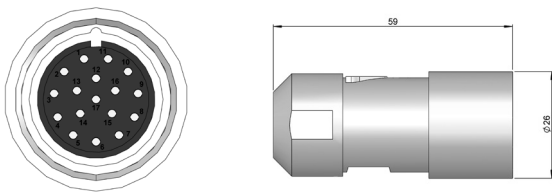

95.0007265
M12 5p horaire

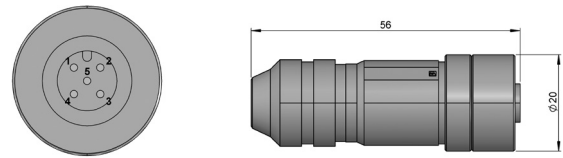

95.0007370
Push-Pull

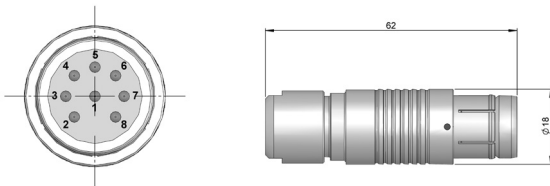

95.0007571
M12 8p anti-horaire

