



## Spring Loaded Arm 90.1202

Technical documentation



The spring loaded arm is suitable for use of measuring wheels between 300mm and 500mm circumference on encoders with 58mm diameter. Due to the innovative 6-hole mounting a trouble-free cable routing is possible. The encoder can be attached to the spring loaded arm from both sides. Due to its highly flexible modular design it can be mounted over 360°. The contact pressure direction of the spring loaded arm can be changed easily and quickly. Thus the mounting can be optionally from below or above the measuring section.

### COMPONENTS

Mounting bracket



Spring loaded arm with spring unit



Clamping cap

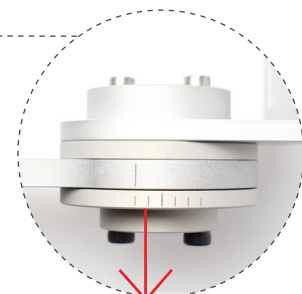
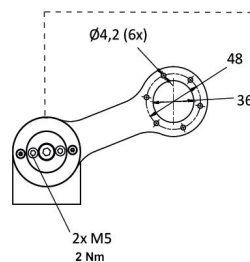
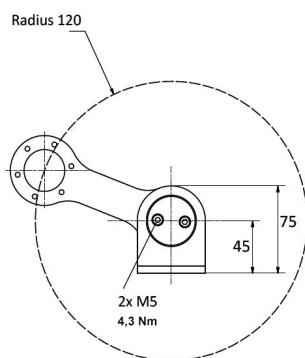
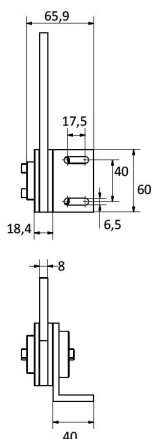
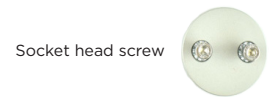

approx. 5/10/15/20/25/30 N  
contact pressure  
Marking in 5N steps

Black Screw Thread M5 = 2,0 Nm tightening torque | Silver Screw Thread M5 = 4,3 Nm tightening torque

## UNPACK SPRING LOADED ARM

Remove the spring loaded arm from the packaging and check for damage. The encoder and measuring wheel can be mounted on the 6-bolt circle. The spring arm is set at the factory with the contact pressure down.

## SAFETY INSTRUCTIONS

- Installation and maintenance may only be carried out by appropriately trained, qualified personnel authorized by your company.
- Opening the spring unit with the centre screw is not permitted (risk of injury due to springs jumping out).
- Change the spring force only when the spring loaded arm is firmly mounted (risk of injury).
- Product should only be used in an industrial environment.
- Do not use in safety-relevant areas.

The preload should be approx. 15 N. This force is adapted to our measuring wheels. Depending on the application, the spring force can be adjusted, but please note that if the deviation from the specified preload is too great, no guarantee can be given for the measuring accuracy.

## CHOOSE REQUIRED POSITION OF THE U-HOLDING ANGLE

To fix the holder, the L-angle can be adjusted between 0° and 360°.

For this purpose, the 2 silver screws (arrow) must be loosened. Select the desired position and tighten the screws.

The contact pressure for the measuring wheel is in the direction of the arrow. The spring loaded arm can now be mounted at the intended location.

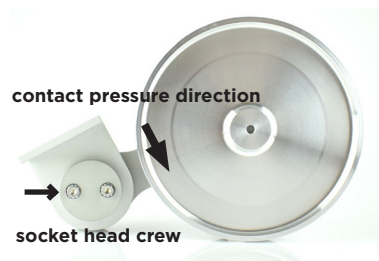
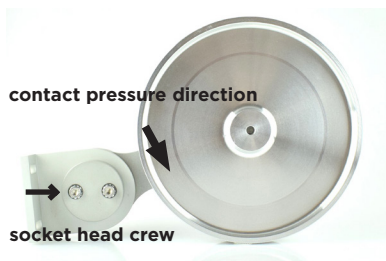
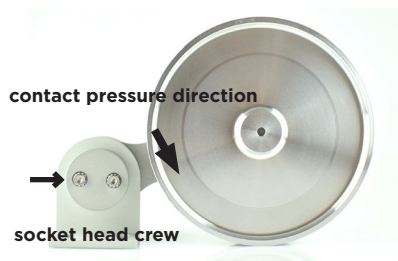

## CHANGE DIRECTION OF THE PRELOAD

To change the preload direction, the spring loaded arm must be turned 180°. To do this, remove the 2 black screws, then the 2 silver screws. Remove the clamping cap.

Turn the spring loaded arm by 180°. Replace the bracket and the clamping cap with the 2 silver screws, adjusting the desired position of the bracket. Finally, screw in the black screws on the opposite side. The contact pressure direction is now up. (see arrow)

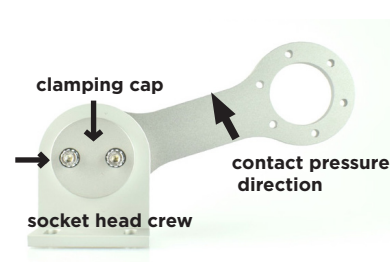
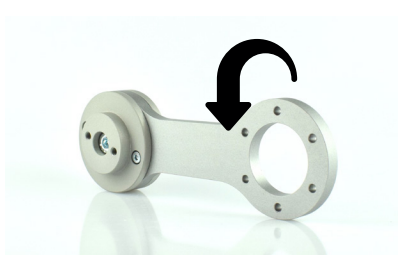
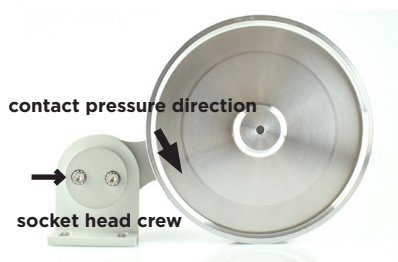

## CHANGE SPRING FORCE

The spring force should only be adjusted with the spring arm mounted. Loosen the silver screws on the clamping cap.

Using a suitable tool, turn between the two black screws on the opposite side in the direction of the measuring wheel until the desired preload is reached. Retighten the silver screws.

