

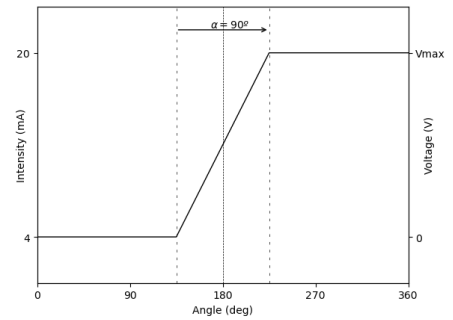

SERIE BME ANA

ON-AXIS BEARINGLESS ABSOLUTE SINGLETURN ENCODER

- Analog output
- Non-contacting measuring system
- Resolution up to 12 bits
- Easy assembly
- High protection class IP65
- Compact dimensions
- Connection by cable (other cable length available)

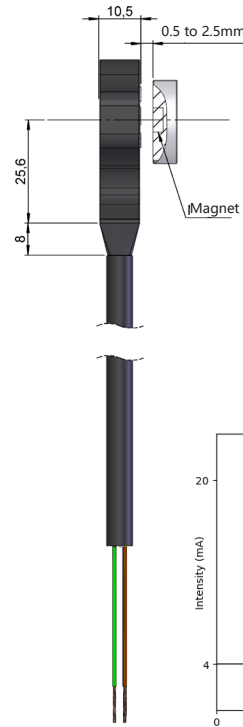
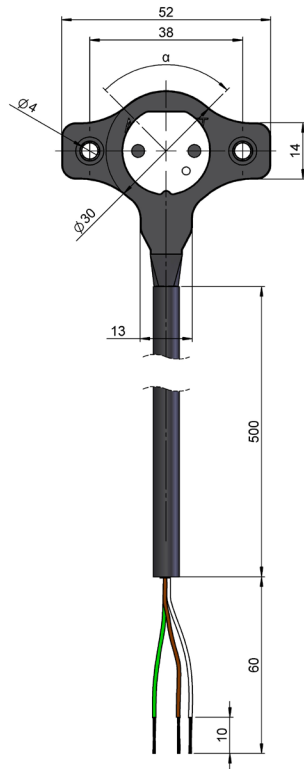

Drawing Magnet type 2, Measurement range 90°

REFERENCE

Reference example: BME-ANA-12116-12180

Serie	Mechanical option	Magnet	Connection	Code	Interface / Supply Voltage	Resolution	Measuring range	Special customer
BME-ANA-	<input type="checkbox"/>	<input type="checkbox"/>	<input type="checkbox"/>	<input type="checkbox"/>	<input type="checkbox"/> -	<input type="checkbox"/> <input type="checkbox"/>	<input type="checkbox"/> <input type="checkbox"/> <input type="checkbox"/> <input type="checkbox"/>	<input type="checkbox"/> <input type="checkbox"/> <input type="checkbox"/> <input type="checkbox"/>
	1. Option A	2. Frontal fixation 3. Clamp fixation 10 mm 4. Clamp fixation 12 mm	1. 50 cm radial cable	1. CW 2. CCW	3. 0-20 mA, 12-18V 4. 4-20 mA, 12-18V 5. 0-20 mA, 20-28V 6. 4-20 mA, 20-28V 7. 0-10V, 15-30V 8. 0-5V, 15-30V	12. 12 bits	180. 180° electrical 360. 360° electrical (*)	

Order your reference Step file 3D

info@encodenhohner.com

service available in 24 h

(*) Measuring range can be factory configured from 18° to 360°.



SERIE BME ANA

ON-AXIS BEARINGLESS ABSOLUTE SINGLETURN ENCODER

MECHANICAL SPECIFICATIONS

Materials	Housing: Polyamide hot melt resin Magnet: Neodymium
Maximum number of revolutions permitted mechanically	3000 rpm
Permitted gap	0.5 mm to 2.5 mm (Magnet option type 2) 0.5 mm to 5.0 mm (Magnet option type 3, 4)
Admissible max. misalignment (radial)	0.2 mm
Protection against dust and splashes according to DIN EN 60529	IP65 (IP67 available, Upon request)
Weight approx.	0,05 Kg
Operating temperature range	-30 to +85°C
Vibration according to DIN EN 60068-2-6	≤ 200 m/s ² (55Hz...2000Hz)
Shock according to DIN EN 60068-2-27	≤ 2000 m/s ² (6ms)
Radial connection	50 cm cable

ELECTRICAL SPECIFICATIONS

Interface	Analog
Electronic output	0..20mA , 4..20mA, 0..5V, 0..10V
Power supply (VCC)	12-18V, 20-28V, 15-30V
Consumption	≤ 30 mA
Resolution	Up to 12 bits
Range	180° and 360° electrical (*)
Short circuit protection	Yes
Protection polarity inversion	Yes

(*) Measuring range can be factory configured from 18° to 360°.

CONNECTION



	Cable 2x2x0,14+1x0,14 95.0008002
GND	White (WH)
+UB	Brown (BN)
I _{out} / V _{out}	Green (GN)
Shield	Green (GN) - Yellow (YE)

MEASURING RANGE

Measuring range 180°

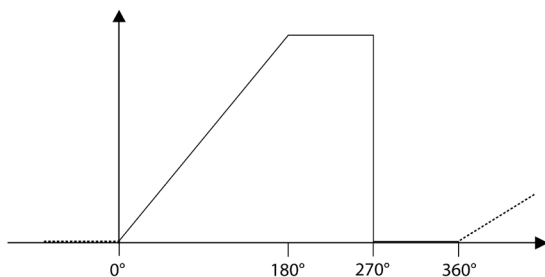

Measuring range 360°

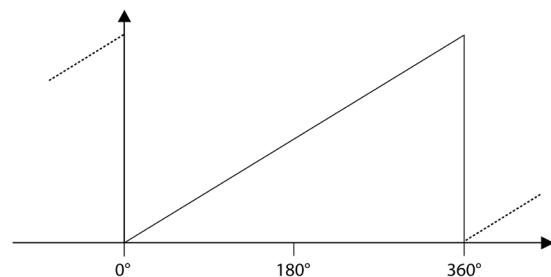

SERIE BME ANA

ON-AXIS BEARINGLESS ABSOLUTE SINGLETURN ENCODER

ACCESSORIES

Magnet 2
Frontal fixation

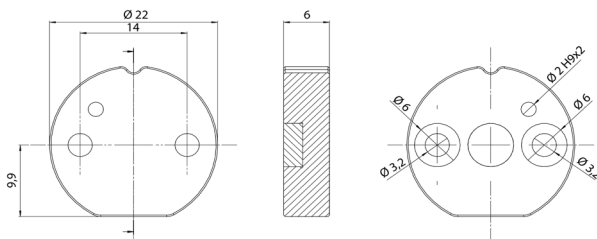

90.5001



Magnet 3
Clamp fixation
10 mm

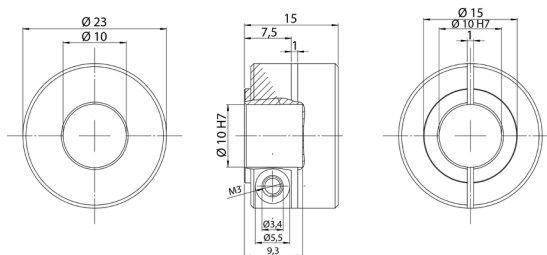

90.5002

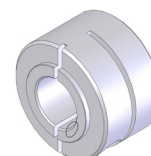

Magnet 4
Clamp fixation
12 mm

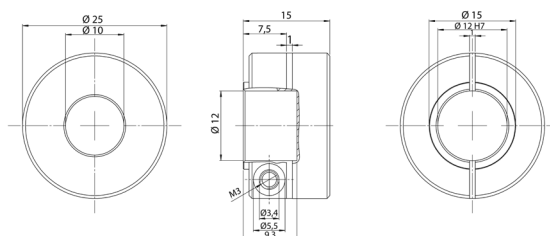

90.5003

