



SERIE IN360A

INCLINOMETER

- Robust metal case protects from shocks and vibrations
- Filling resin protects against thermal shocks, moisture and harsh environments
- 1D and 2D inclination measurement
- Protection class IP67
- Analog output (4-20 mA or 0.5-4.5 V)
- Protected against reverse bias



Inclinometer



1 axis



2 axes



IP 67



Temperature range



Express Delivery

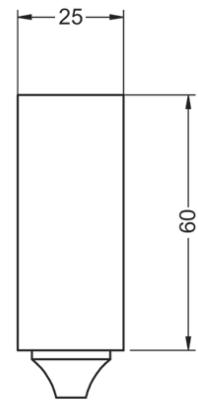
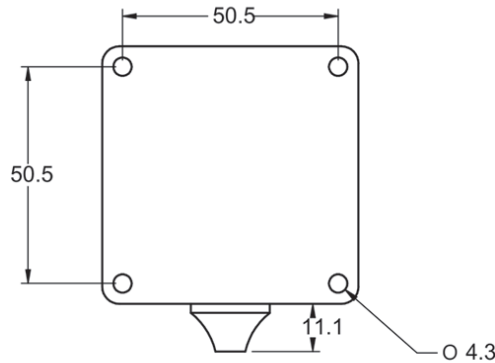
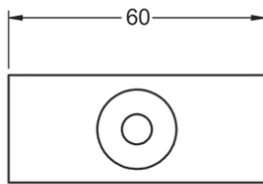

REFERENCE

Reference example: IN360A-114

Serie	Interface	Number of axis / Measuring range	Connection	Output signal	Special Customer
IN360	A -	<input type="checkbox"/>	<input type="checkbox"/>	<input type="checkbox"/>	<input type="checkbox"/> <input type="checkbox"/> <input type="checkbox"/> <input type="checkbox"/>
	A. Analog output	1. 1 axis / 0...360° 2. 2 axes / ± 30°	1. Cable (0,5m)	4. 4...20 mA 5. 0,5...4,5 V	



SERIE IN360A

INCLINOMETER

MECHANICAL SPECIFICATIONS

Materials	Housing: Anodized aluminium
Protection according to DIN EN 60529	IP67
Weight	200 g
Storage temperature range	-40° to +85°C
Operating temperature range	-40° to +85°C
Connection	0,5m open lead cable

ELECTRICAL SPECIFICATIONS

Range of measurement	0...360° (1 axis) ±30° (2 axes)
Resolution	7.33 µA (4...20 mA) 1.67 mV (0,5...4,5 V)
Supply Voltage	12/24 V (7...30 V)
Current consumption*	40 mA
Accuracy	±0.20° (max ±0.50°)
Temperature drift	±0.008°/°C
Load resistor	250 Ω; max 500 Ω (4...20 mA) 10 kΩ (0,5...4,5 V)

(*) Sensor current consumption is 40mA. At X and Y full scale (20mA+20mA), the total current consumption is 80mA.

CONNECTION

	Open lead cable
IU - Internal use only (leave it open if present)	1
VCC - Power supply	2
GND - Ground	3
OUTX - Analog output (x-axis in 2-axes mode and 1-axis mode)	4
OUTY* - Analog output (y-axis in 2-axes mode)	5

(*) OUTY - Not connected in 1-axis mode

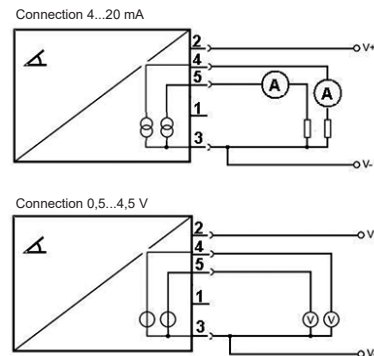

1 AXIS

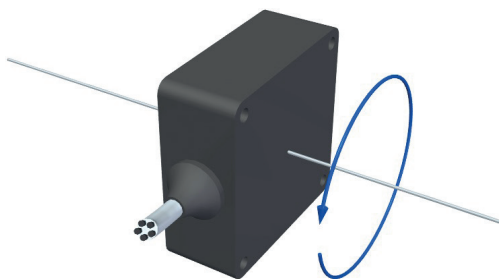

2 AXES

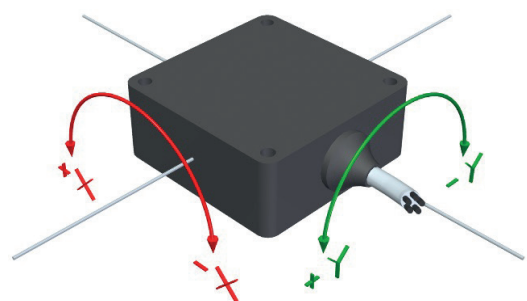

Zero degrees on the single-axis model (vertical operation position) are obtained by keeping the connector to the left.

In order to get the high accuracy performances, we suggest to fix the inclinometer with 4 countersunk screws, placed at the edges of the 4 slot-holes.

SERIE IN360A

INCLINOMETER

OUTPUT CHARACTERISTICS

1 AXIS - 4...20 mA

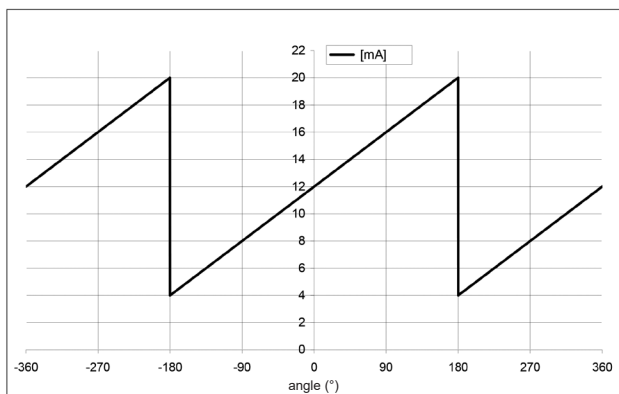

1 AXIS - 0,5...4,5 V

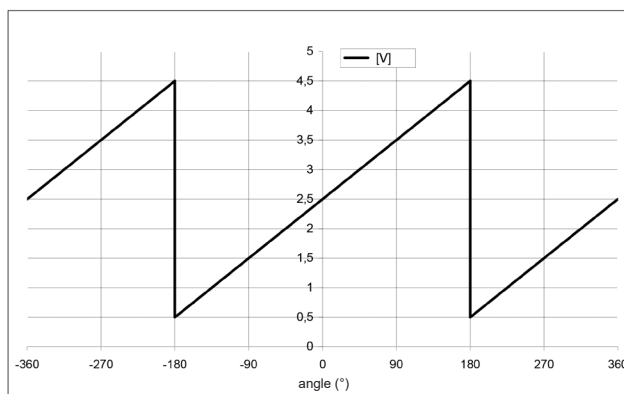

2 AXES - 4...20 mA

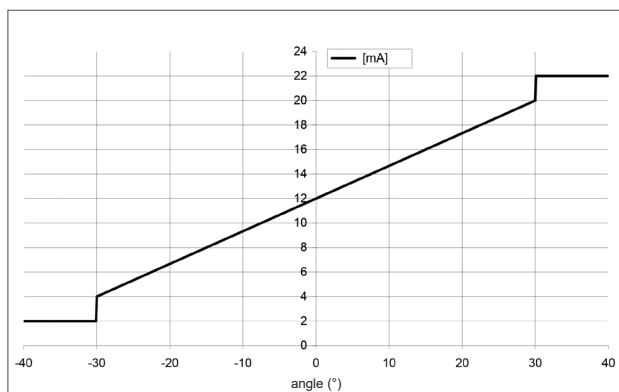

2 AXES - 0,5...4,5 V

